

BC550

Rev.F Mar.-2016

描述 / Descriptions

TO-92(R)塑封封装 NPN 半导体三极管。Silicon NPN transistor in a TO-92(R) Plastic Package.

特征 / Features

高电压，低噪声。

High Voltage, Low Noise.

用途 / Applications

用于低噪声放大。

Low noise amplifier application.

内部等效电路 / Equivalent Circuit

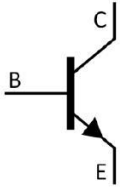

引脚排列 / Pinning



PIN1 : Emitter

PIN 2 : Base

PIN 3 : Collector

放大及印章代码 / h_{FE} Classifications & Marking

h_{FE} Classifications Symbol	A	B	C
h_{FE} Range	110~220	200~450	420~800

极限参数 / Absolute Maximum Ratings(Ta=25°C)

参数 Parameter	符号 Symbol	数值 Rating	单位 Unit
Collector to Base Voltage	V_{CBO}	50	V
Collector to Emitter Voltage	V_{CEO}	45	V
Emitter to Base Voltage	V_{EBO}	5.0	V
Collector Current - Continuous	I_C	100	mA
Collector Power Dissipation	P_C	625	mW
Junction Temperature	T_j	150	°C
Storage Temperature Range	T_{stg}	-55~150	°C

电性能参数 / Electrical Characteristics(Ta=25°C)

参数 Parameter	符号 Symbol	测试条件 Test Conditions	最小值 Min	典型值 Typ	最大值 Max	单位 Unit
Collector to Emitter Breakdown Voltage	V_{CEO}	$I_C=10mA$ $I_B=0$	45			V
Collector to Base Breakdown Voltage	V_{CBO}	$I_C=10\mu A$ $I_E=0$	50			V
Emitter to Base Breakdown Voltage	V_{EBO}	$I_E=10\mu A$ $I_C=0$	5.0			V
Collector Cut-Off Current	I_{CBO}	$V_{CB}=30V$ $I_E=0$			0.015	μA
DC Current Gain	h_{FE}	$V_{CE}=5.0V$ $I_C=2.0mA$	110		800	
Collector-Emitter Saturation Voltage	$V_{CE(sat)}$	$I_C=100mA$ $I_B=5.0mA$			0.6	V
Base-Emitter Saturation Voltage	$V_{BE(sat)}$	$I_C=100mA$ $I_B=5.0mA$		0.9		V
Base-Emitter Voltage	$V_{BE(on)}$	$V_{CE}=5.0V$ $I_C=2.0mA$	0.55		0.7	V
Current Gain Bandwidth Product	f_T	$V_{CE}=5.0V$ $f=100MHz$ $I_E=10mA$		300		MHz
Transition Frequency	C_{ob}	$V_{CB}=10V$ $f=1.0MHz$ $I_E=0$			4.5	pF
Noise Figure	NF	$V_{CE}=5.0V$ $R_g=10K\Omega$ $I_C=200\mu A$ $f=1.0KHz$			10	dB

电参数曲线图 / Electrical Characteristic Curve

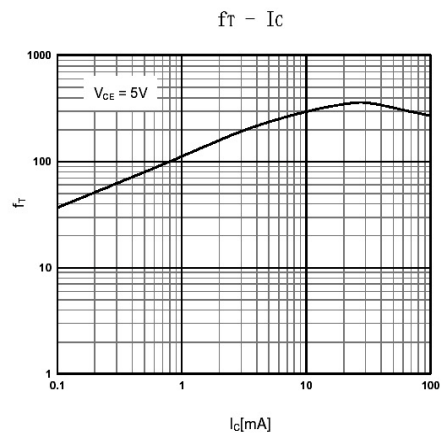
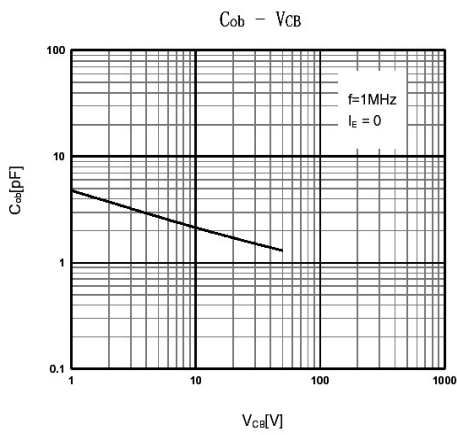
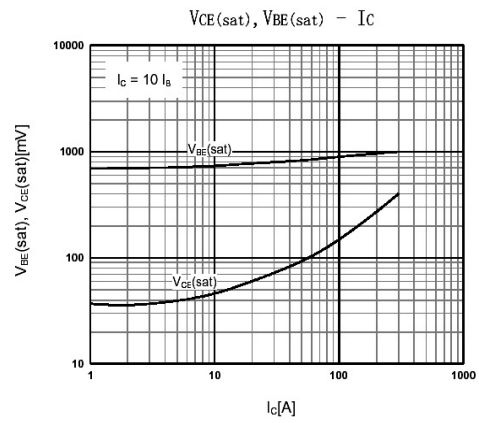
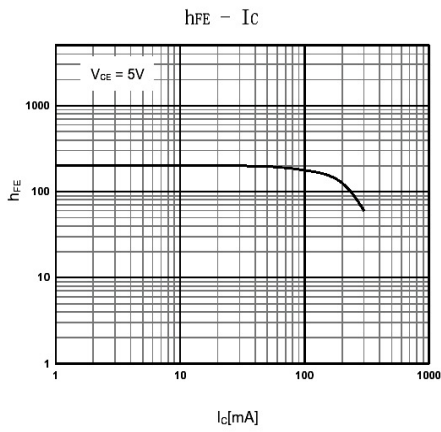
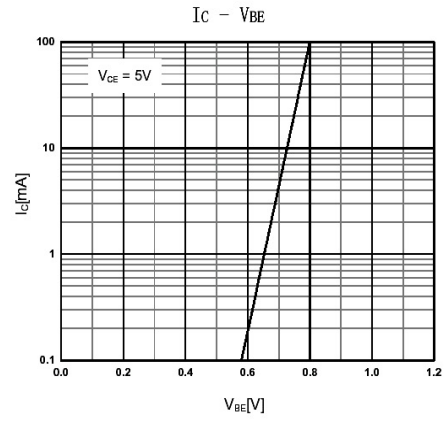
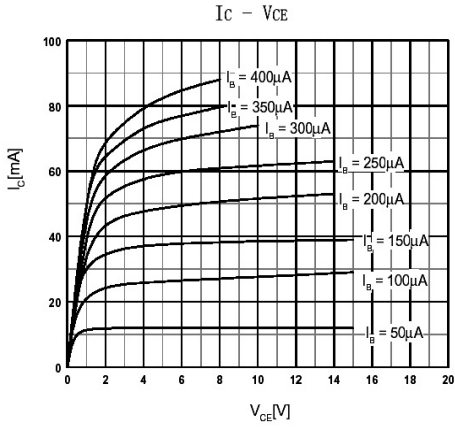

外形尺寸图 / Package Dimensions

TO-92(R)

Unit: mm

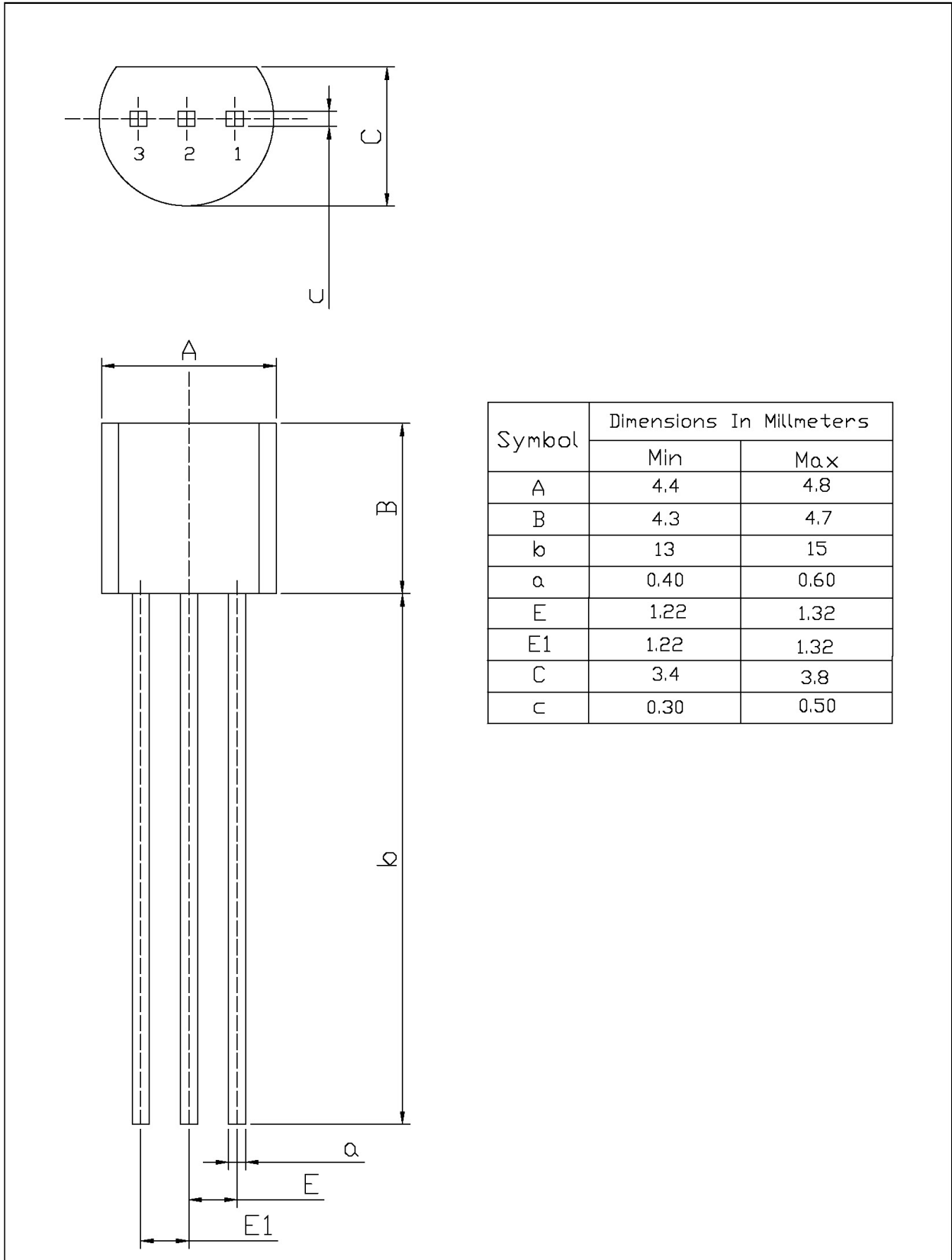

印章说明 / Marking Instructions

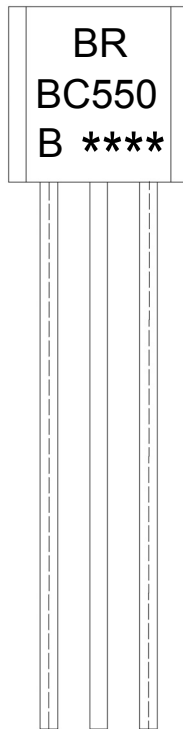

说明：

BR： 为公司代码

BC550： 为产品型号

B： 为 h_{FE} 分档代码

****： 为生产批号代码，随生产批号变化。

Note:

BR: Company Code.

BC550: Product Type.

B: h_{FE} Classifications Symbol

****: Lot No. Code, code change with Lot No.

波峰焊温度曲线图(无铅) / Temperature Profile for Dip Soldering(Pb-Free)



说明：

- 1、预热温度 25 ~ 150°C，时间 60 ~ 90sec;
- 2、峰值温度 255±5°C，时间持续为 5±0.5sec;
- 3、焊接制程冷却速度为 2 ~ 10°C/sec.

Note:

- 1.Preheating:25~150°C, Time:60~90sec.
- 2.Peak Temp.:255±5°C, Duration:5±0.5sec.
3. Cooling Speed: 2~10°C/sec.

耐焊接热试验条件 / Resistance to Soldering Heat Test Conditions

温度：270±5°C

时间：10±1 sec.

Temp.:270±5°C

Time:10±1 sec

包装规格 / Packaging SPEC.

散件包装 / BULK

Package Type 封装形式	Units 包装数量					Dimension 包装尺寸 (unit: mm3)		
	Units/Bag 只/袋	Bags/Inner Box 袋/盒	Units/Inner Box 只/盒	Inner Boxes/Outer Box 盒/箱	Units/Outer Box 只/箱	Bag 袋	Inner Box 盒	Outer Box 箱
TO-92	1,000	10	10,000	5	50,000	135×190	237×172×102	560×245×195
	1,000	10	10,000	10	100,000	135×190	237×172×102	560×245×375

编带包装 / AMMO

Package Type 封装形式	Units 包装数量					Dimension 包装尺寸 (unit: mm3)	
	Units/tape 只/纸带	Tape/Inner Box 纸带/盒	Rows/Inner Box 纸带层/盒	Inner Boxes/Outer Box 盒/箱	Units/Outer Box 只/箱	Inner Box 盒	Outer Box 箱
TO-92	3,000	1	120	10	30,000	328×230×42	小箱 480×346×235, 大箱 547×407×268

使用说明 / Notices